

CON SCARICO TRUCIOLO LATERALE E PUNTA PILOTA.

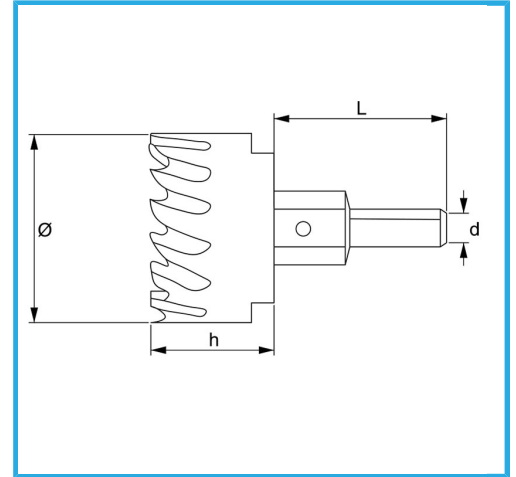

€11,30



Ø	18 mm
h	23 mm
d	10 mm
L	46 mm
Filetto	M12 x 1,25
Peso lordo	0,09 kg
Dimensioni imballo	30x30x120 h mm
Codice EAN	8012667313531



Append.

HSS