

MIT SEITLICHEM CHIP UND MITTELBOHRER.

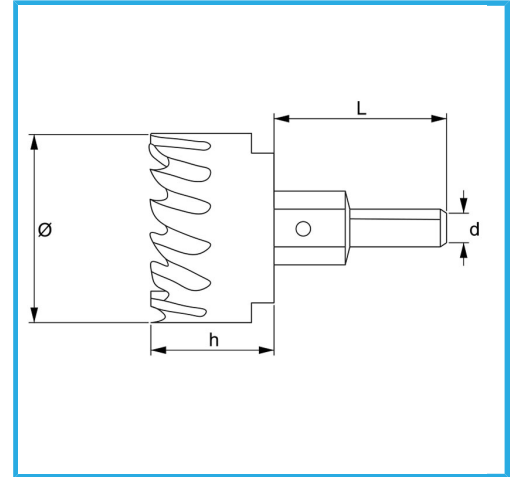

Ø	45 mm
h	23 mm
d	10 mm
L	56 mm
Gewinde	M14 x 1,5
Bruttogewicht	0,26 kg
EAN-Code	8012667313807



Aufhängbar

HSS