

ZUM VIBRATIONSFREIEN KONISCHEN ANSENKEN.

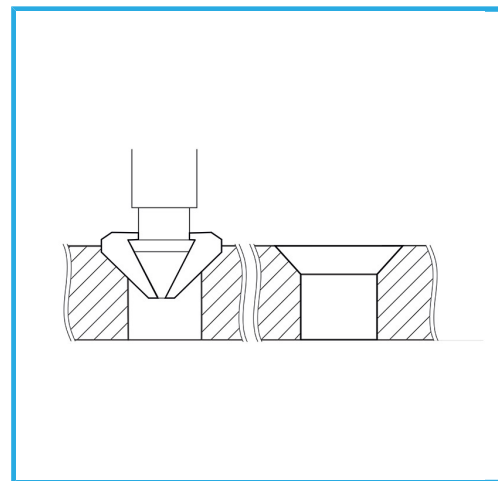

∅	6,3 mm
Gesamtlänge	31 mm
Schaftgröße	1/4" HEX x 25 mm
Bruttogewicht	0,01 kg
EAN-Code	8012667311551



Box



90°

HSS
M2

-