

TO PERFORM CONICAL COUNTERSINKS WITHOUT VIBRATIONS.

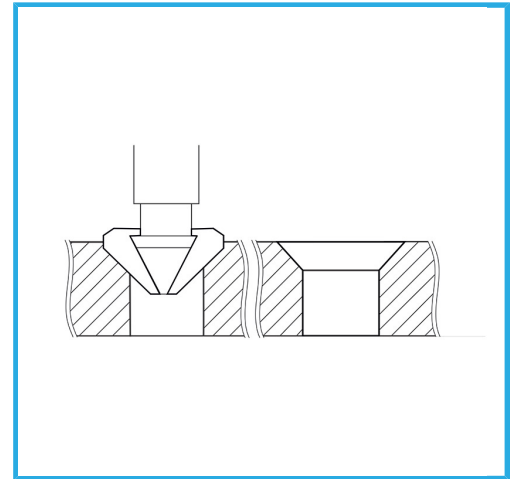

∅	10,4 mm
Total length	34 mm
Shank dimensions	1/4" HEX x 25 mm
Gross weight	0,01 kg
EAN Code	8012667311827



Box



90°

HSS
M2

-