

PARA REALIZAR AVELLANADOS CÓNICOS SIN VIBRACIONES.

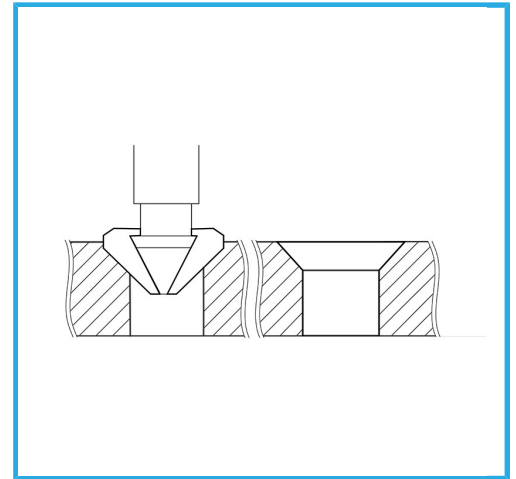

€11,30



∅	12,4 mm
Longitud total	35 mm
Dimensiones pata	1/4" HEX x 25 mm
Peso bruto	0,02 kg
Codigo de barras	8012667311834



Caja



90°

HSS  
M2

-