

PARA REALIZAR AVELLANADOS CÓNICOS SIN VIBRACIONES.

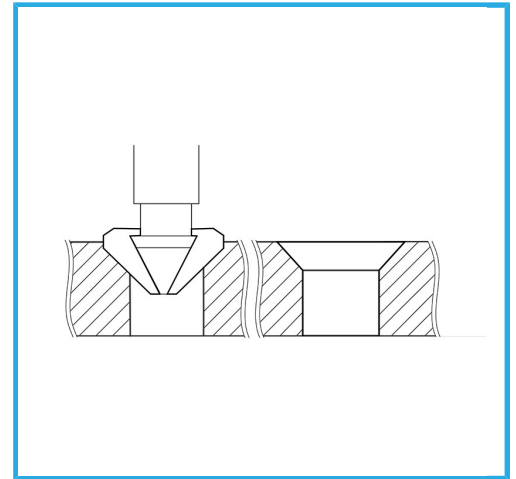

€12,40



Ø	16,5 mm
Longitud total	40 mm
Dimensiones pata	1/4" HEX x 25 mm
Peso bruto	0,03 kg
Codigo de barras	8012667311841



Caja



90°

HSS  
M2

-