

ZUM VIBRATIONSFREIEN KONISCHEN ANSENKEN.

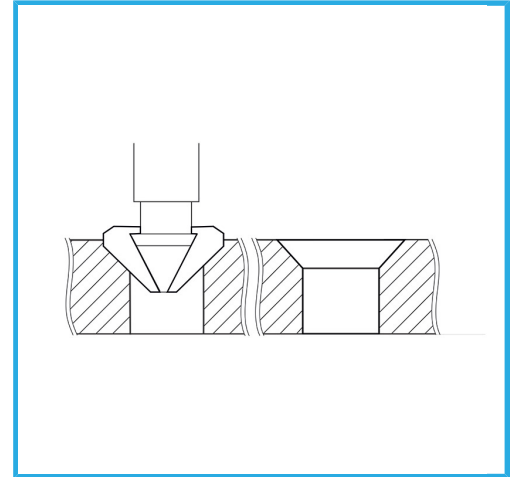

∅	20,5 mm
Gesamtlänge	41 mm
Schaftgröße	1/4" HEX x 25 mm
Bruttogewicht	0,04 kg
EAN-Code	8012667311858



Box



90°

HSS  
M2

-