

TO PERFORM CONICAL COUNTERSINKS WITHOUT VIBRATIONS.

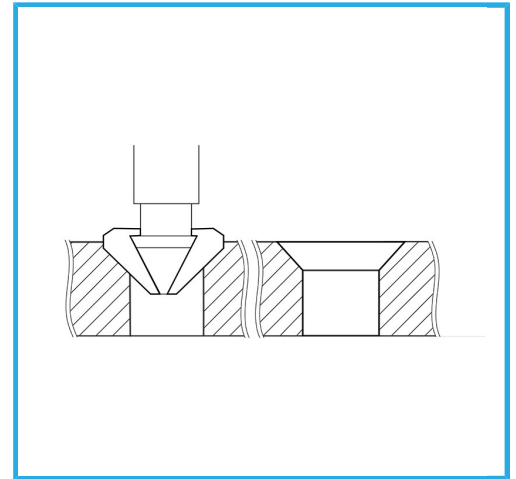

∅	20,5 mm
Total length	41 mm
Shank dimensions	1/4" HEX x 25 mm
Gross weight	0,04 kg
EAN Code	8012667311858



Box



90°

HSS
M2

-