

PARA REALIZAR AVELLANADOS CÓNICOS SIN VIBRACIONES.

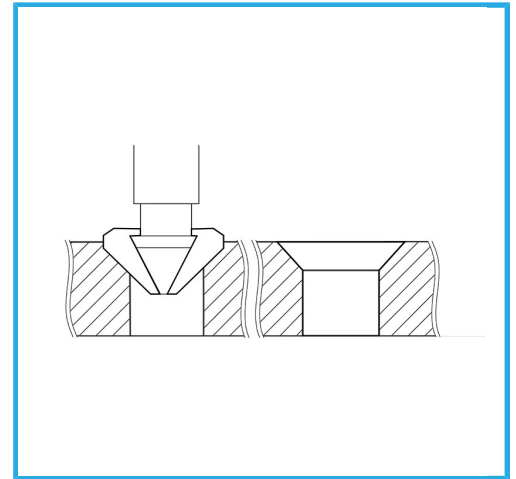

€14,40



Ø	20,5 mm
Longitud total	41 mm
Dimensiones pata	1/4" HEX x 25 mm
Peso bruto	0,04 kg
Codigo de barras	8012667311858



Caja



90°

HSS
M2

-