

PROF. AUSFÜHRUNG, VERBUNDWERKSTOFF, HANDGRIFF UND KOPF
AUS SCHLAGABSORBIERENDEM GUMMI. BEDIENUNGSHEBEL,
WECHSEL DER...

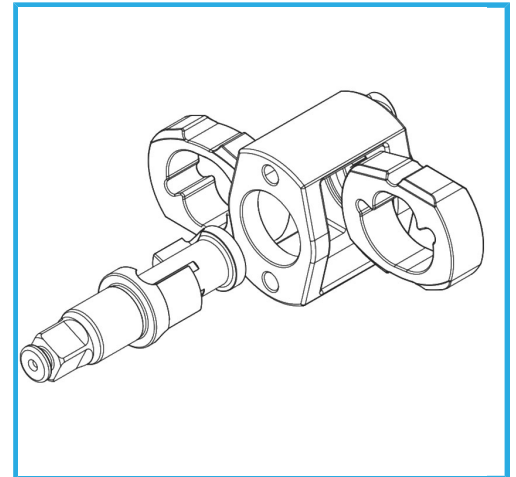

Geschwindigkeit	7800 rpm
max. Drehmoment	678 Nm 500 lb-ft
geschätzter Luftverbrauch	136 l/min 4.8 SCFM
Betriebsdruck	6 bar 90 psi
Luftanschluss	1/4"
Nettogewicht	1,2 kg
Verpackungsmaße	200 x 190 x 65 h mm
Bruttogewicht	1,33 kg
EAN-Code	8012667346287

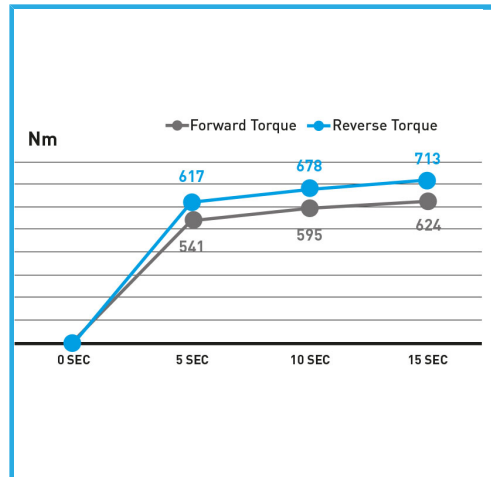

Box



1/2"