

FÜR VORGEBOHRTE GEWINDE.

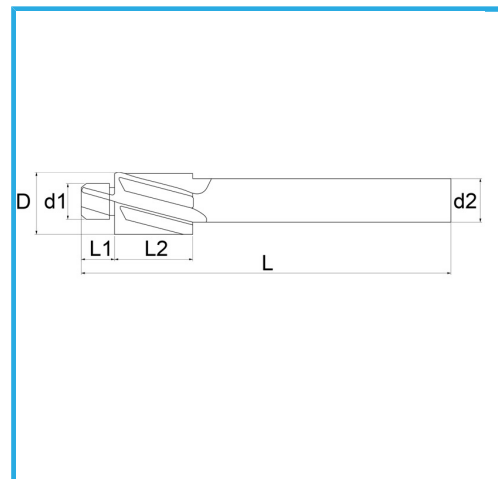

Schrauben	M10
D	18 mm
d1	8,5 mm
d2	12,5 mm
L1	14 mm
L2	22 mm
L	100 mm
Bruttogewicht	0,10 kg
EAN-Code	8012667346638

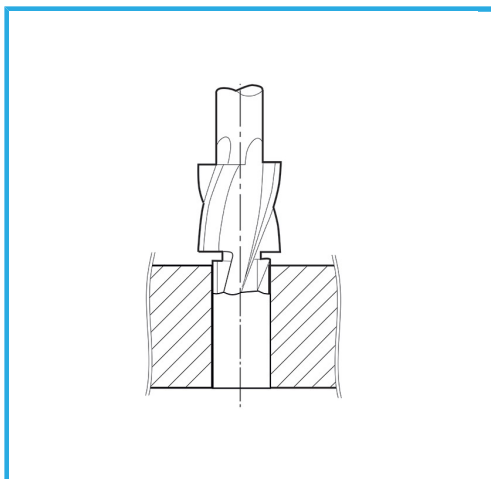

Box



Extern



373



-



-