

WITH BURNISHED MAGNETIC TIP, HANDLE IN TWO-COMPONENT MATERIAL WITH FREE END PART TO ROTATE FOR A PERFECT GRIP.

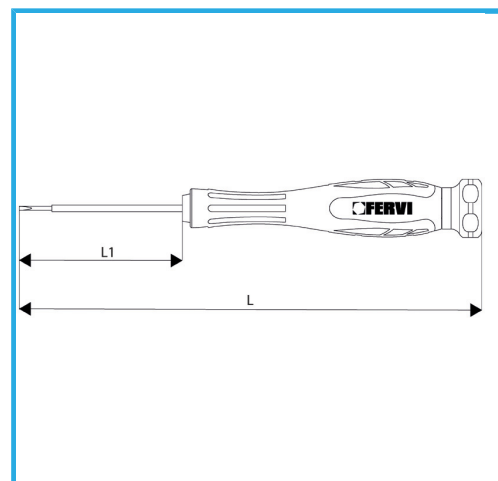

Size	3,5 mm
Pole length	50 mm
Total length	140 mm
Gross weight	0,02 kg
Packaging dimensions	19x19x143h
EAN Code	8012667349028



Phosphated



-