

CON PUNTA MAGN3TICA BRUÑIDA, MANGO EN MATERIAL DE DOS COMPONENTES CON EXTREMO LIBRE PARA GIRAR PARA UN AGARRE...

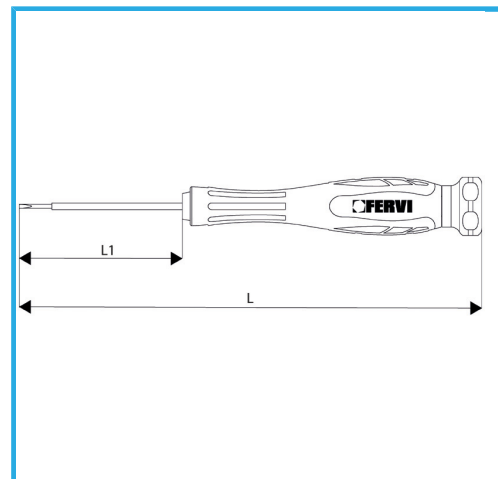

€2,82



Medida	1,8 mm
Longitud barra	50 mm
Longitud total	140 mm
Peso bruto	0,01 kg
Codigo de barras	8012667348984



Fosfatado



-