

CON PUNTA MAGNETICA BRUNITA, IMPUGNATURA IN MATERIALE BICOMPONENTE CON PARTE TERMINALE LIBERA DI RUOTARE PER UN PERFETTO GRIP.

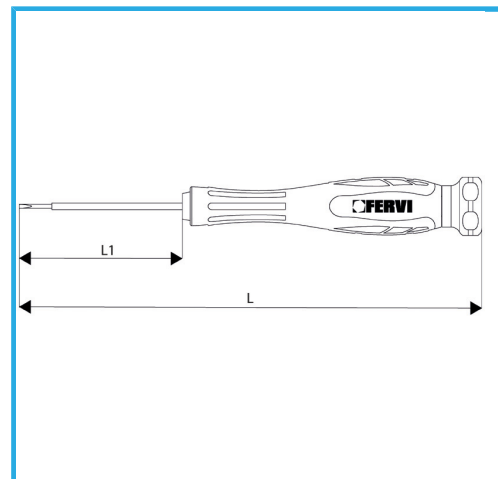

€2,82



Misura	1,8 mm
Lunghezza asta	50 mm
Lunghezza totale	140 mm
Peso lordo	0,01 kg
Codice EAN	8012667348984



Fosfatata



Cr-V