

CON PUNTA MAGNETICA BRUNITA, IMPUGNATURA IN MATERIALE BICOMPONENTE CON PARTE TERMINALE LIBERA DI RUOTARE PER UN PERFETTO GRIP.

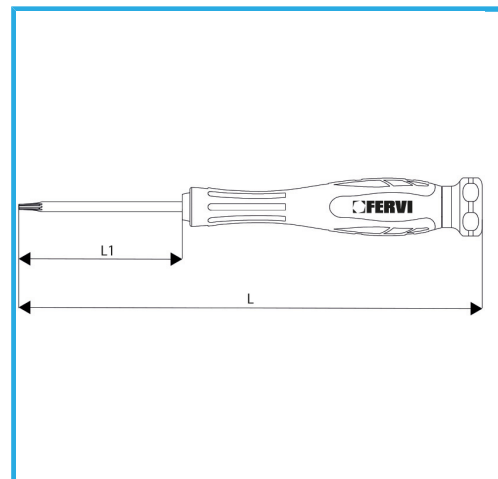

€2,82



Misura	T7 mm
Lunghezza asta	50 mm
Lunghezza totale	140 mm
Peso lordo	0,02 kg
Codice EAN	8012667349097



Cr-V



Fosfatata