

MIT POLIERTEM MAGNETBOHRER, GRIFF AUS
ZWEIKOMPONENTENMATERIAL MIT DREHBAREM ENDTEIL FÜR
PERFEKTEN HALT.

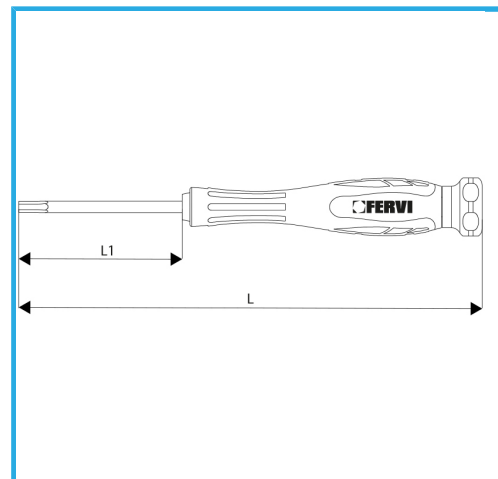

Maß	2,0 mm
Stangenlänge	50 mm
Gesamtlänge	140 mm
Bruttogewicht	0,02 kg
EAN-Code	8012667349172



Phosph.



-



-