

PER IL MONTAGGIO DI UTENSILI CON GAMBO CONICO MORSE.

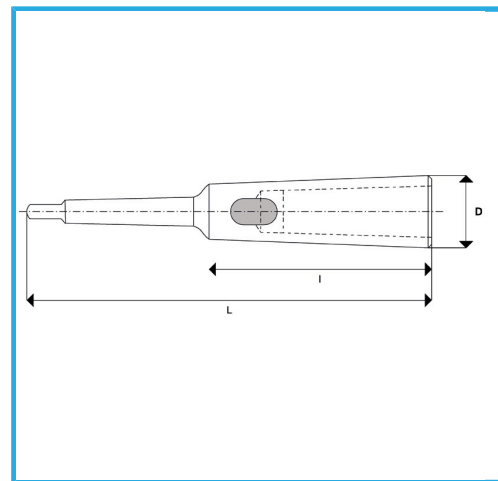

€23,80



CM Esterno	2
CM Interno	2
L	175 mm
I	90 mm
D	30 mm
Peso lordo	0,51 kg
Codice EAN	8012667349592



Scatola



Temprato



Acciaio



Rettificato