

PARA EL MONTAJE DE HERRAMIENTAS CON TORNILLO DE BANCO CÓNICO.

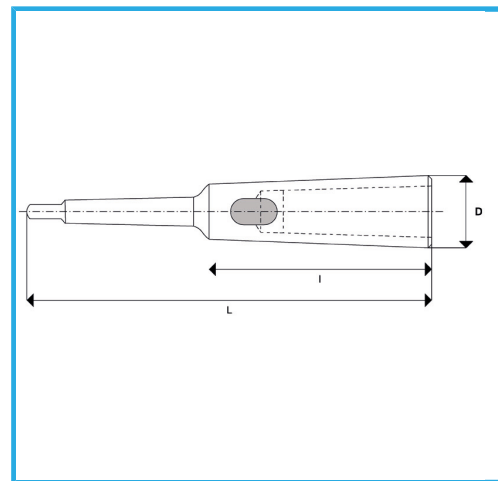

€54,90



CM Externo	4
CM Interior	4
L	265 mm
I	147,5 mm
D	48 mm
Peso bruto	1,90 kg
Codigo de barras	8012667349684



Caja



Templado



Acero



Rectificado