

FOR MOUNTING TOOLS WITH TAPERED SHANK VICES.

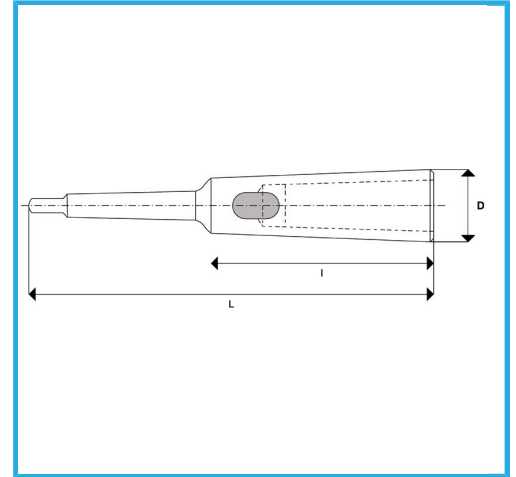

MT External	5
MT Internal	3
L	268 mm
I	118,5 mm
D	36 mm
Gross weight	2,15 kg
EAN Code	8012667349721



Box



Tempered



Steel



Grounded