

PER IL MONTAGGIO DI UTENSILI CON GAMBO CONICO MORSE.

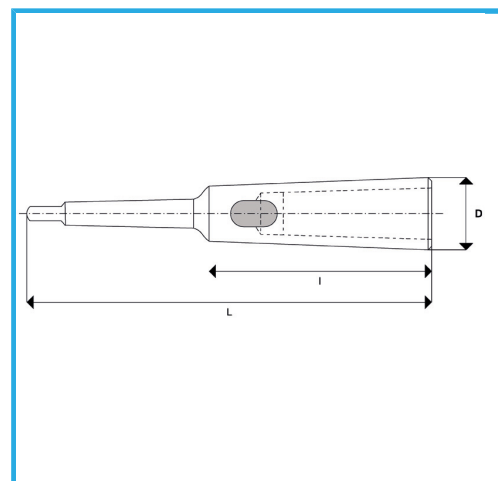

€27,10



CM Esterno	2
CM Interno	3
L	196 mm
I	121 mm
D	36 mm
Peso lordo	0,76 kg
Codice EAN	8012667349608



Scatola



Temprato



Acciaio



Rettificato