

PER IL MONTAGGIO DI UTENSILI CON GAMBO CONICO MORSE.

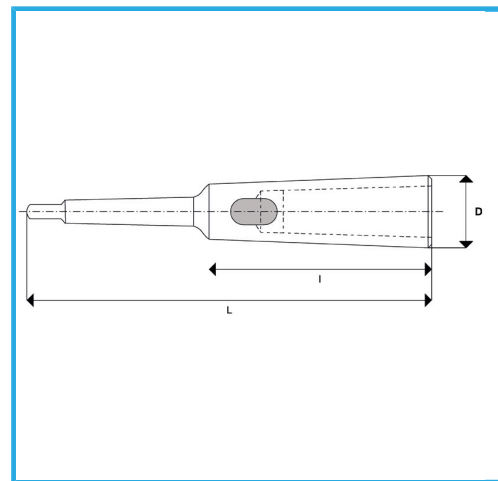

€49,40



CM Esterno	4
CM Interno	3
L	240 mm
I	122,5 mm
D	36 mm
Peso lordo	1,23 kg
Codice EAN	8012667349677



Scatola



Temprato



Acciaio



Rettificato