

PARA EL MONTAJE DE HERRAMIENTAS CON TORNILLO DE BANCO CÓNICO.

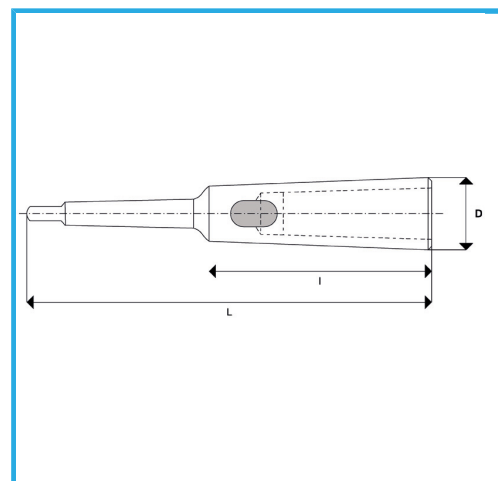

€39,60



CM Externo	4
CM Interior	1
L	200 mm
I	82,5 mm
D	20 mm
Peso bruto	0,75 kg
Codigo de barras	8012667349653



Caja



Templado



Acero



Rectificado