

PER IL MONTAGGIO DI UTENSILI CON GAMBO CONICO MORSE.

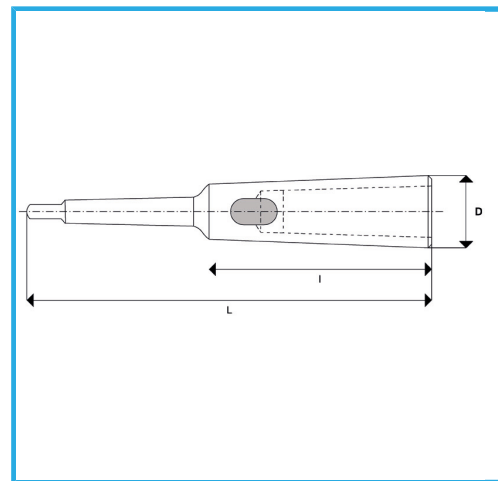

€39,60



CM Esterno	4
CM Interno	1
L	200 mm
I	82,5 mm
D	20 mm
Peso lordo	0,75 kg
Dimensioni imballo	245 x 40 x 40 h mm
Codice EAN	8012667349653



Scatola



Temprato



Acciaio



Rettificato