

PARA EL MONTAJE DE HERRAMIENTAS CON TORNILLO DE BANCO CÓNICO.

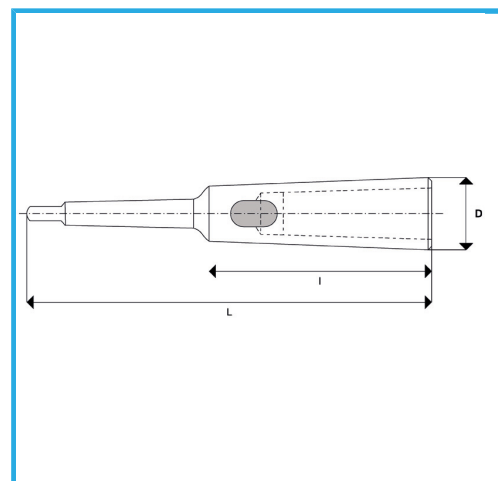

€65,20



CM Externo	5
CM Interior	2
L	247 mm
I	97,5 mm
D	30 mm
Peso bruto	1,92 kg
Codigo de barras	8012667349714



Caja



Templado



Acero



Rectificado