

PARA EL MONTAJE DE HERRAMIENTAS CON TORNILLO DE BANCO CÓNICO.

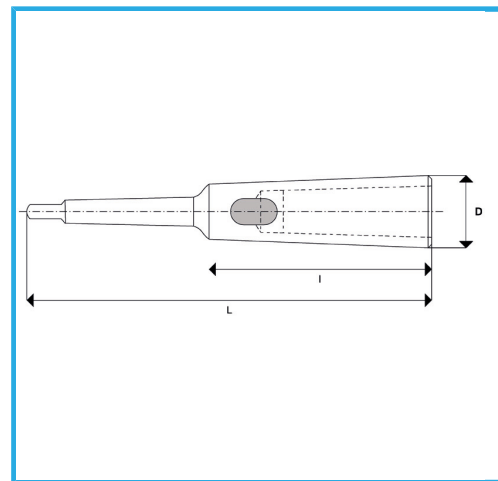

€78,70



CM Externo	4
CM Interior	5
L	300 mm
I	182,5 mm
D	63 mm
Peso bruto	3,40 kg
Codigo de barras	8012667349691



Caja



Templado



Acero



Rectificado