

PARA EL MONTAJE DE HERRAMIENTAS CON TORNILLO DE BANCO CÓNICO.

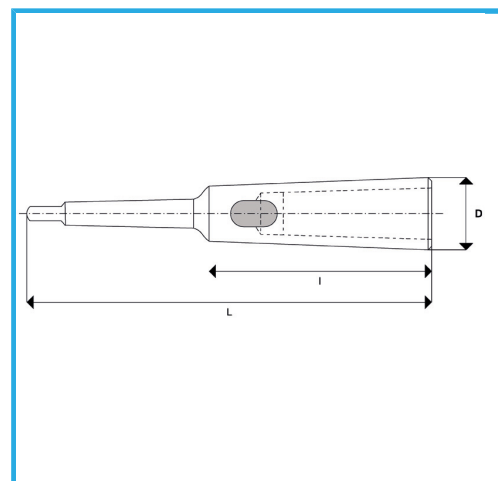

€73,80



CM Externo	5
CM Interior	4
L	300 mm
I	150,5 mm
D	48 mm
Peso bruto	2,77 kg
Codigo de barras	8012667349738



Caja



Templado



Acero



Rectificado