

PER IL MONTAGGIO DI UTENSILI CON GAMBO CONICO MORSE.

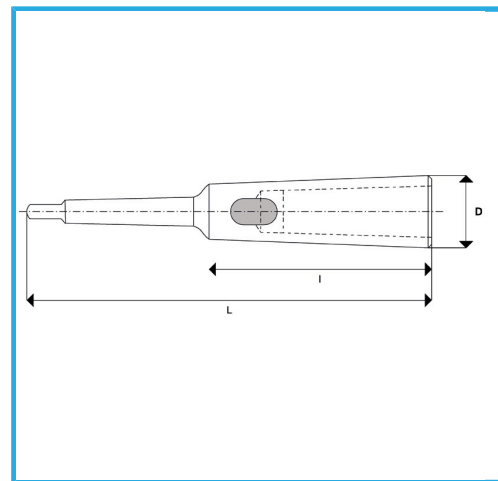

€73,80



CM Esterno	5
CM Interno	4
L	300 mm
I	150,5 mm
D	48 mm
Peso lordo	2,77 kg
Dimensioni imballo	305 x 55 x 55 h mm
Codice EAN	8012667349738



Scatola



Temprato



Acciaio



Rettificato