

PARA EL MONTAJE DE HERRAMIENTAS CON TORNILLO DE BANCO CÓNICO.

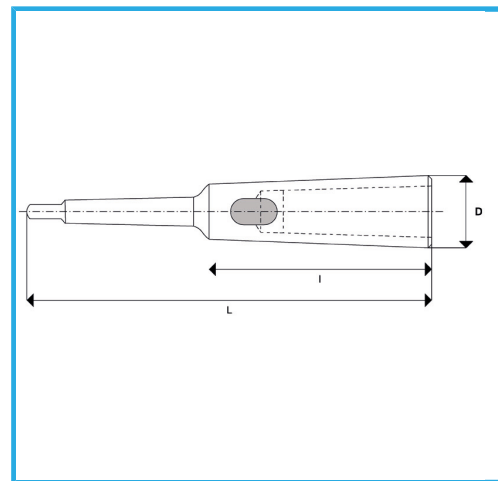

€40,80



CM Externo	4
CM Interior	2
L	215 mm
I	97,5 mm
D	30 mm
Peso bruto	1,00 kg
Codigo de barras	8012667349660



Caja



Templado



Acero



Rectificado