

PER IL MONTAGGIO DI UTENSILI CON GAMBO CONICO MORSE.

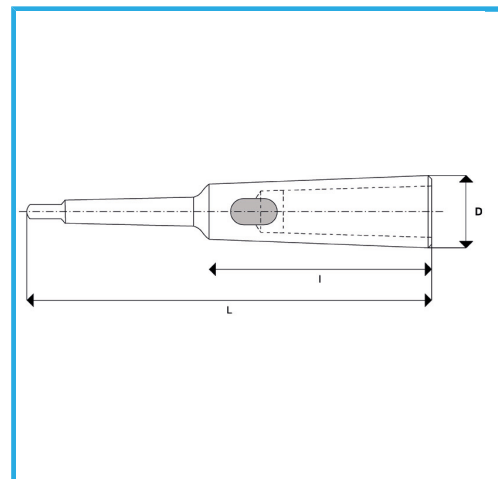

€25,60



CM Esterno	3
CM Interno	1
L	175 mm
I	81 mm
D	20 mm
Peso lordo	0,42 kg
Dimensioni imballo	180 x 30 x 30 h mm
Codice EAN	8012667349615



Scatola



Temprato



Acciaio



Rettificato