

ART. C855/T15
CHIAVI TORX CON MANICO IN PLASTICA

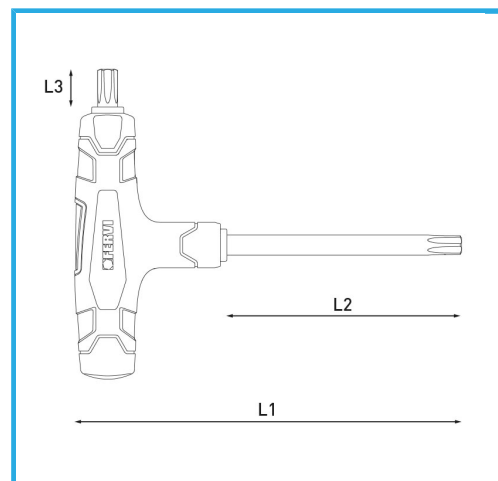

€4,23



Misura	T15
L1	175 mm
L2	130 mm
L3	10 mm
Peso lordo	0,04 kg
Codice EAN	8012667362492



Append.



Fosfatata

