

€18,20

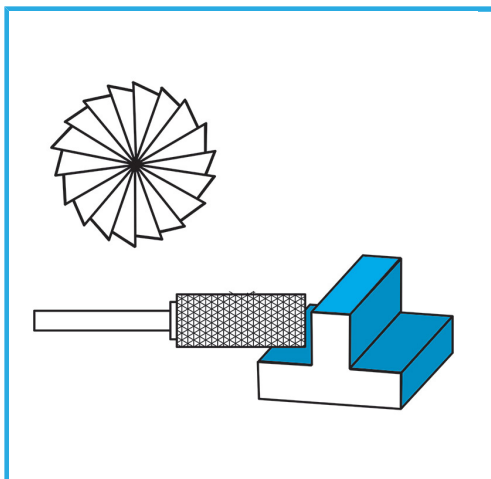

D1	ø10 mm
L1	20 mm
D2	6 mm
L2	65 mm
Dimensioni imballo	17 x 95 x 17 h mm
Peso lordo	0,04 kg
Codice EAN	8012667356514



Scatola



HM