

€17,20

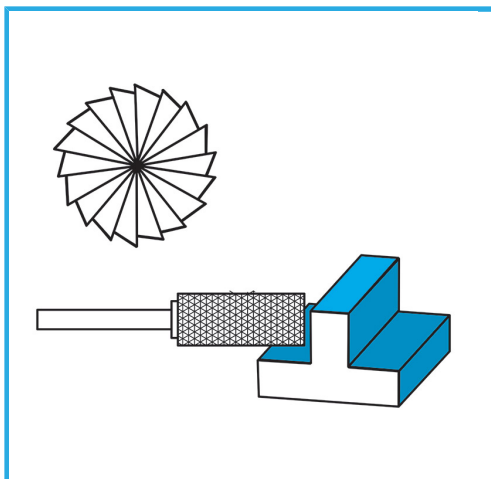

D1	ø8 mm
L1	20 mm
D2	6 mm
L2	65 mm
Dimensioni imballo	16 x 95 x 16 h mm
Peso lordo	0,03 kg
Codice EAN	8012667356675



Scatola



HM