

€30,10

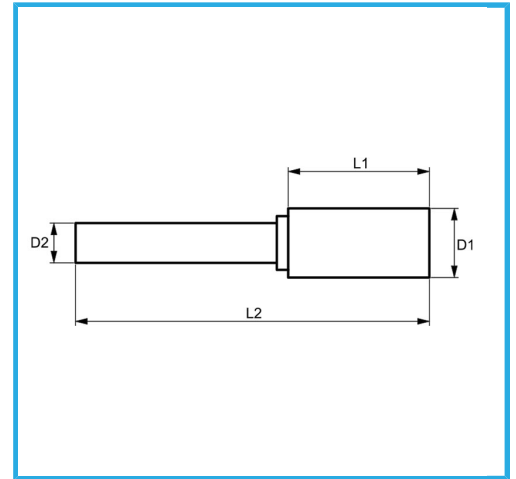

D1	ø12 mm
L1	25 mm
D2	6 mm
L2	70 mm
Dimensioni imballo	16 x 95 x 16 h mm
Peso lordo	0,03 kg
Codice EAN	8012667356699

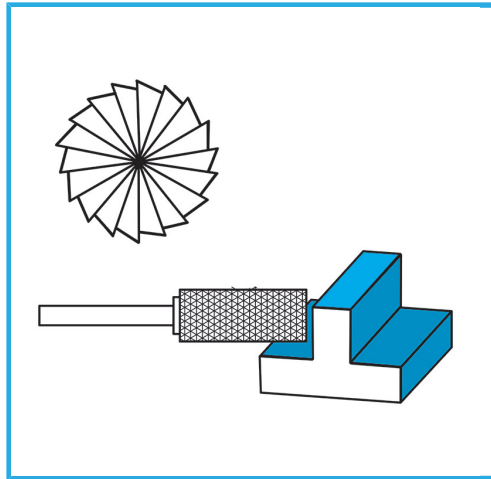

Scatola



HM