

€29,10

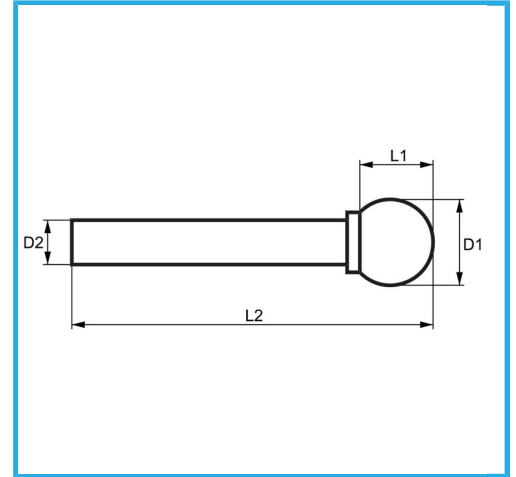

D1	ø16 mm
L1	14.4 mm
D2	6 mm
L2	60 mm
Dimensioni imballo	23 x 98 x 23 h mm
Peso lordo	0,05 kg
Codice EAN	8012667357139

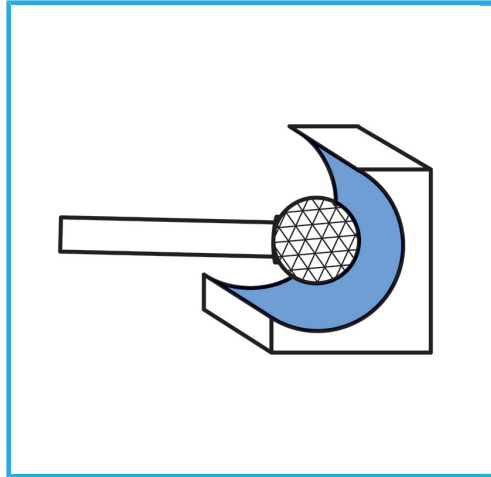

Scatola



HM

-