

€26,60

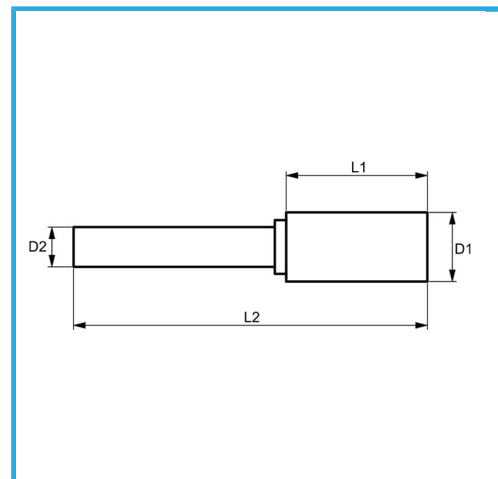

D1	ø12 mm
L1	25 mm
D2	6 mm
L2	70 mm
Peso lordo	0,05 kg
Codice EAN	8012667356361

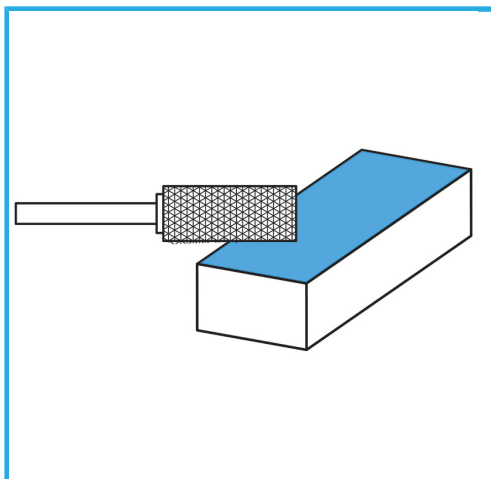

Scatola



HM