

€16,10

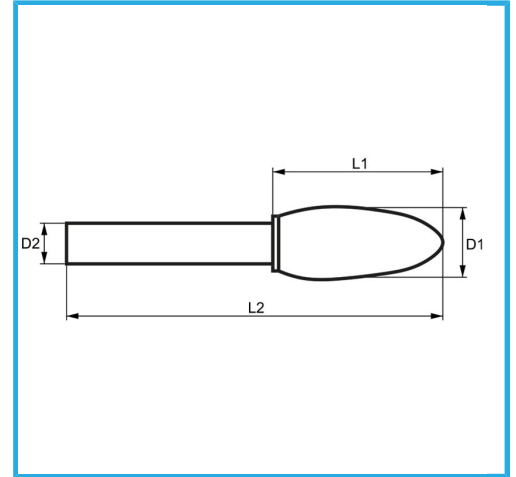

D1	ø8 mm
D2	20 mm
L1	6 mm
L2	65 mm
Dimensioni imballo	95 x 20 x 20 h mm
Peso lordo	0,02 kg
Codice EAN	8012667357696

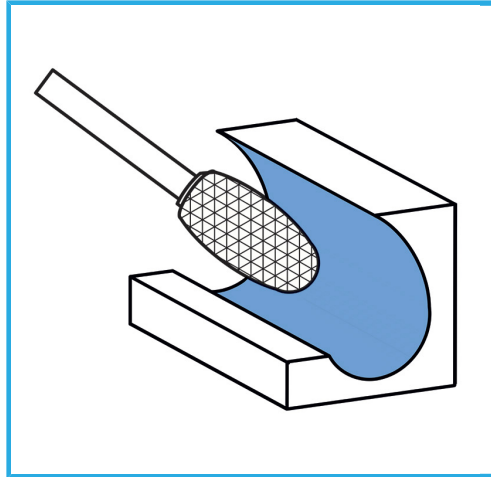

Scatola



-