

€26,60

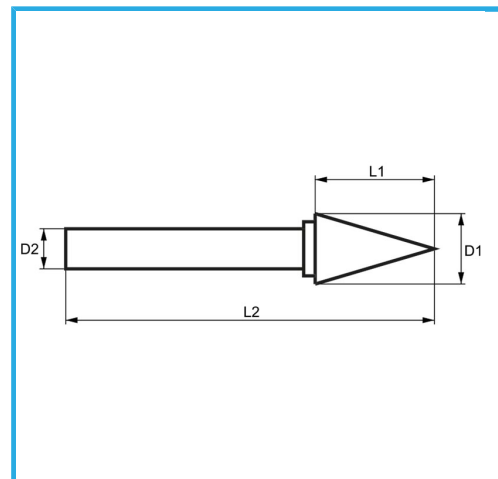

D1	ø12 mm
L1	25 mm
D2	6 mm
L2	70 mm
Dimensioni imballo	95 x 20 x 20 h mm
Peso lordo	0,03 kg
Codice EAN	8012667357818

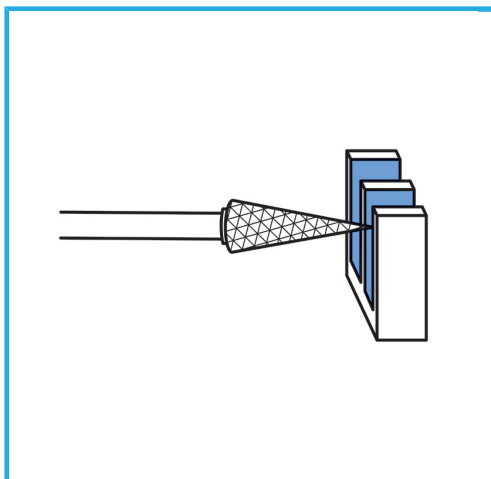

Scatola



-