

€10,40

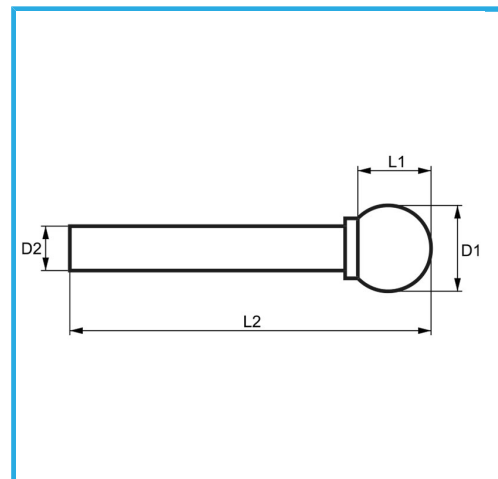

D1	ø4 mm
L1	3.6 mm
D2	6 mm
L2	38 mm
Dimensioni imballo	17 x 95 x 17 h mm
Peso lordo	0,02 kg
Codice EAN	8012667357085

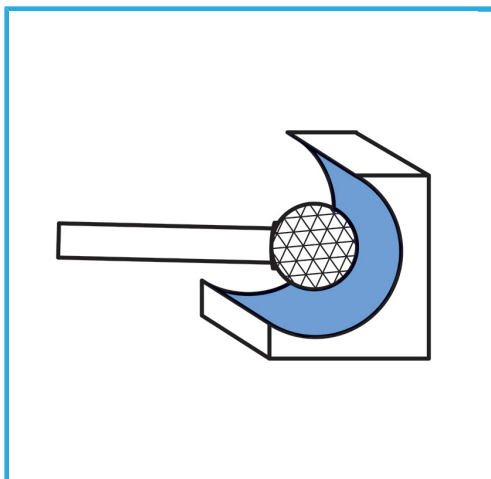

Scatola



HM

-