

€14,60

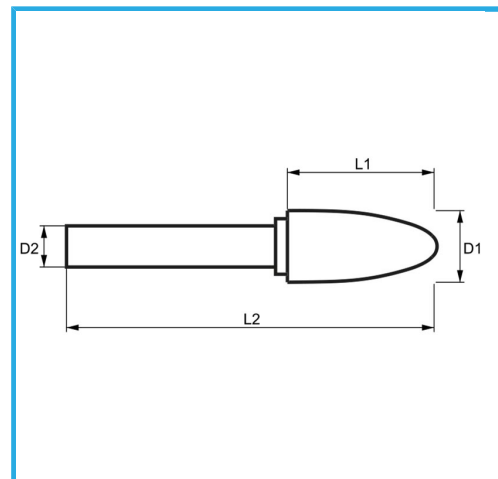

D1	ø8 mm
D2	20 mm
L1	6 mm
L2	65 mm
Peso lordo	0,03 kg
Dimensioni imballo	17 x 95 x 17 h mm
Codice EAN	8012667357382

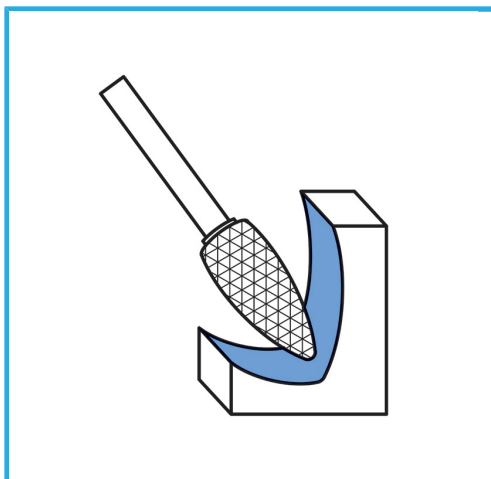

Scatola



HM