

€4,67

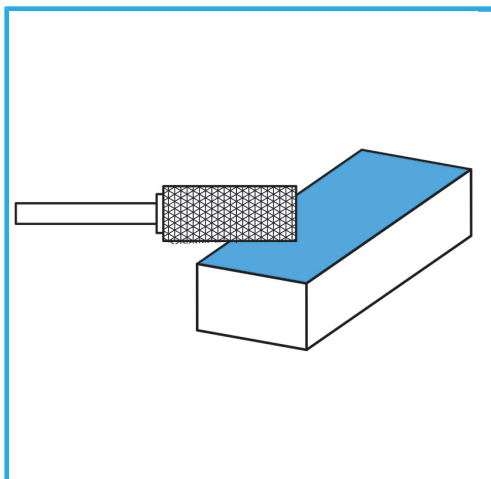

D1	ø2 mm
L1	10 mm
D2	3 mm
L2	38 mm
Dimensioni imballo	13 x 55 x 13 h mm
Peso lordo	0,01 kg
Codice EAN	8012667356323



Scatola



HM