

€18,20

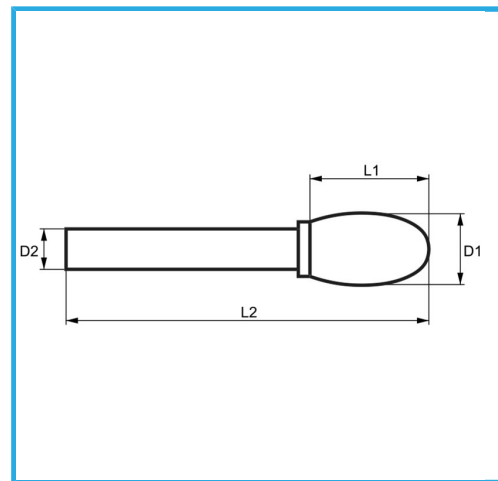

D1	ø10 mm
L1	16 mm
D2	6 mm
L2	61 mm
Peso lordo	0,03 kg
Codice EAN	8012667357269

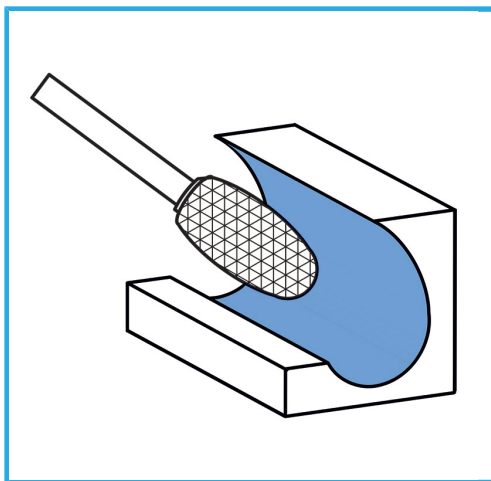

Scatola



-