

ZUM BOHREN MITTLERER UND GROßER LÖCHER IN DIE WAND.

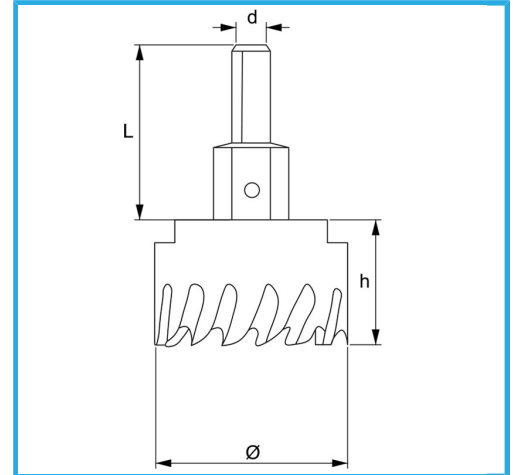

Ø	90 mm
d	12 mm
Gewinde	M16 x 1.5
Z	9
L	46 mm
Bohrer	Ø8 x 69 mm
Bruttogewicht	0,63 kg
EAN-Code	8012667352738



Aufhängbar

HSS



HM

-