

FOR DRILLING MEDIUM AND LARGE HOLES IN THE WALL.

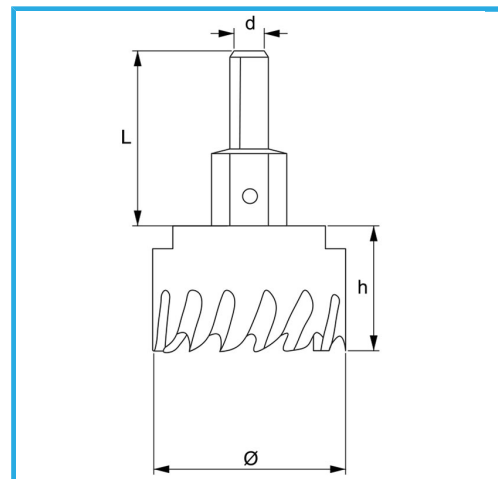

<b>Ø</b>	90 mm
<b>d</b>	12 mm
<b>Thread</b>	M16 x 1.5
<b>Z</b>	9
<b>L</b>	46 mm
<b>Boring bit</b>	Ø8 x 69 mm
<b>Gross weight</b>	0,63 kg
<b>EAN Code</b>	8012667352738



Hangable

**HSS**

**HM**

-