

**ART. P076/090**  
CORONAS CON DIENTES DE METAL DURO PARA  
CONSTRUCCION



PARA TALADRAR AGUJEROS MEDIANOS Y GRANDES EN LA PARED.



€80,90

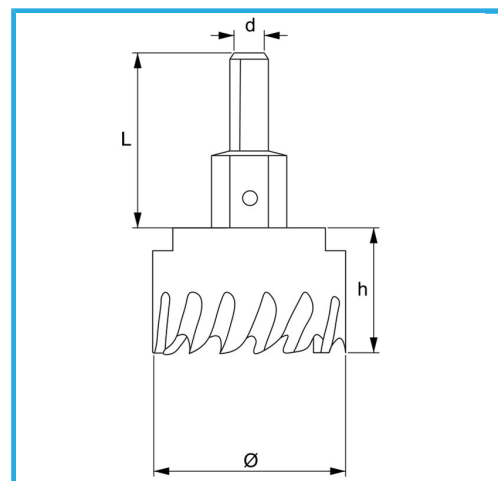

Ø	90 mm
d	12 mm
Rosca	M16 x 1.5
Z	9
L	46 mm
Broca	Ø8 x 69 mm
Peso bruto	0,63 kg
Codigo de barras	8012667352738



Colgante

HSS

HM