

EL NÚCLEO DE DIAMANTE DE PARED DELGADA GARANTIZA CORTES SIN REBABAS. ESTA CARACTERÍSTICA FACILITA EL TRABAJO DE...

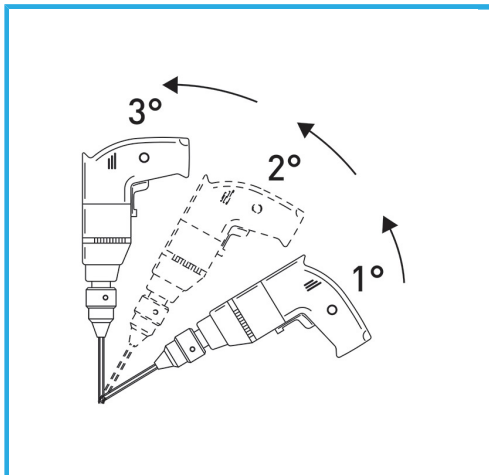

€111,00



Medida	Ø 60 mm
Conexión hexagonal	11 mm
Longitud total	90 mm
Altura del diamante	5 mm
Grano	35/40
Peso bruto	0,35 kg
Codigo de barras	8012667355272



Colgante