

FOR DRILLING MEDIUM AND LARGE HOLES IN THE WALL.

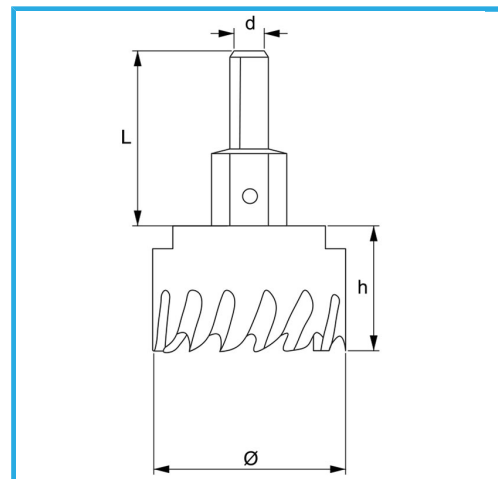

Ø	45 mm
d	10 mm
Thread	M12 x 1.25
Z	5
L	46 mm
Boring bit	Ø6 x 69 mm
Gross weight	0,25 kg
Packaging dimensions	60x60x120 h mm
EAN Code	8012667352653



Hangable

HSS

HM

-