

PER L'ESECUZIONE DI FORI DI MEDIE E GRANDI DIMENSIONI NEL MURO.

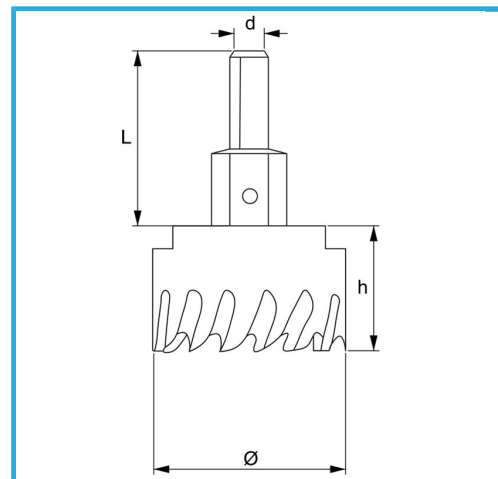

€30,80



Ø	45 mm
d	10 mm
Filetto	M12 x 1.25
Z	5
L	46 mm
Punta	Ø6 x 69 mm
Peso lordo	0,25 kg
Codice EAN	8012667352653



Append.

HSS

HM

-