

ZUM BOHREN MITTLERER UND GROßER LÖCHER IN DIE WAND.

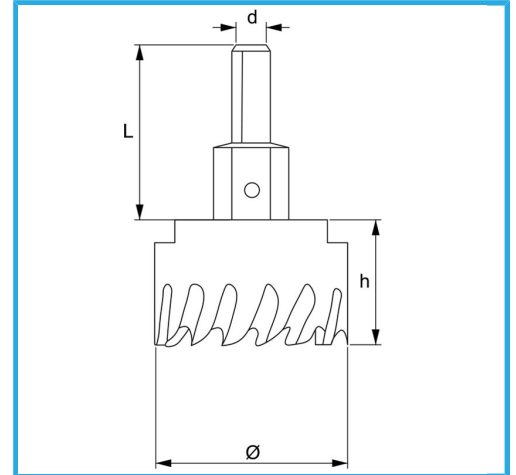

Ø	95 mm
d	12 mm
Gewinde	M16 x 1.5
Z	10
L	46 mm
Bohrer	Ø8 x 69 mm
Bruttogewicht	0,68 kg
EAN-Code	8012667352745



Aufhängbar

HSS

HM

-