

PER L'ESECUZIONE DI FORI DI MEDIE E GRANDI DIMENSIONI NEL MURO.

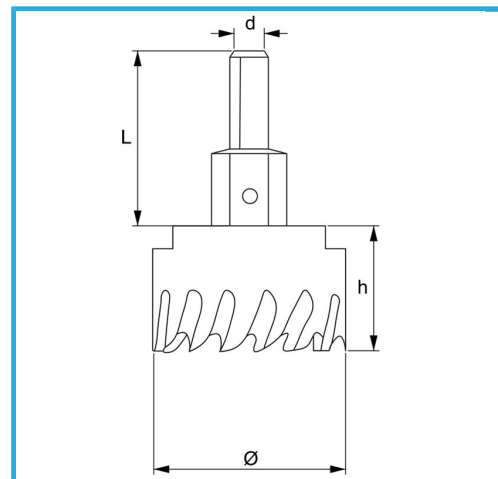

€81,90



Ø	95 mm
d	12 mm
Filetto	M16 x 1.5
Z	10
L	46 mm
Punta	Ø8 x 69 mm
Peso lordo	0,68 kg
Codice EAN	8012667352745



Append.

HSS

HM