

ZUM BOHREN MITTLERER UND GROßER LÖCHER IN DIE WAND.

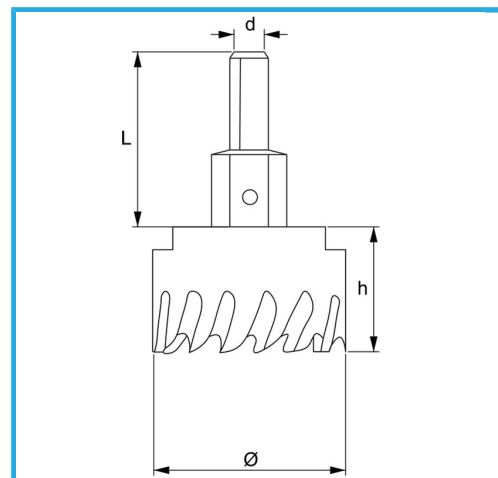

Ø	25 mm
d	10 mm
Gewinde	M12 x 1.25
Z	3
L	46 mm
Bohrer	Ø6 x 69 mm
Bruttogewicht	0,13 kg
EAN-Code	8012667352592



Aufhängbar

HSS

HM

-